

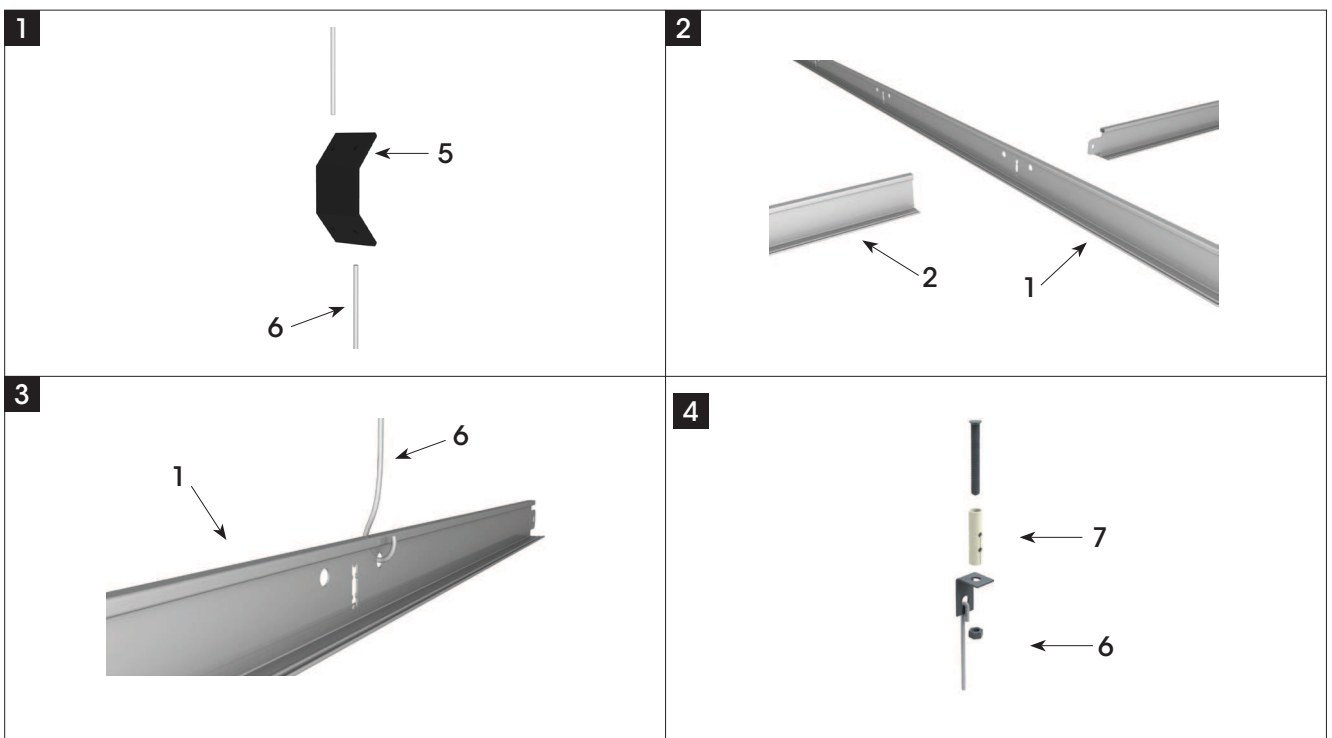

# INTEGRA TILE INTEGRA TILE

Lay-in Tile Sistem  
Lay-in Tile System

Lay-in Flat  
Lay-in Flat

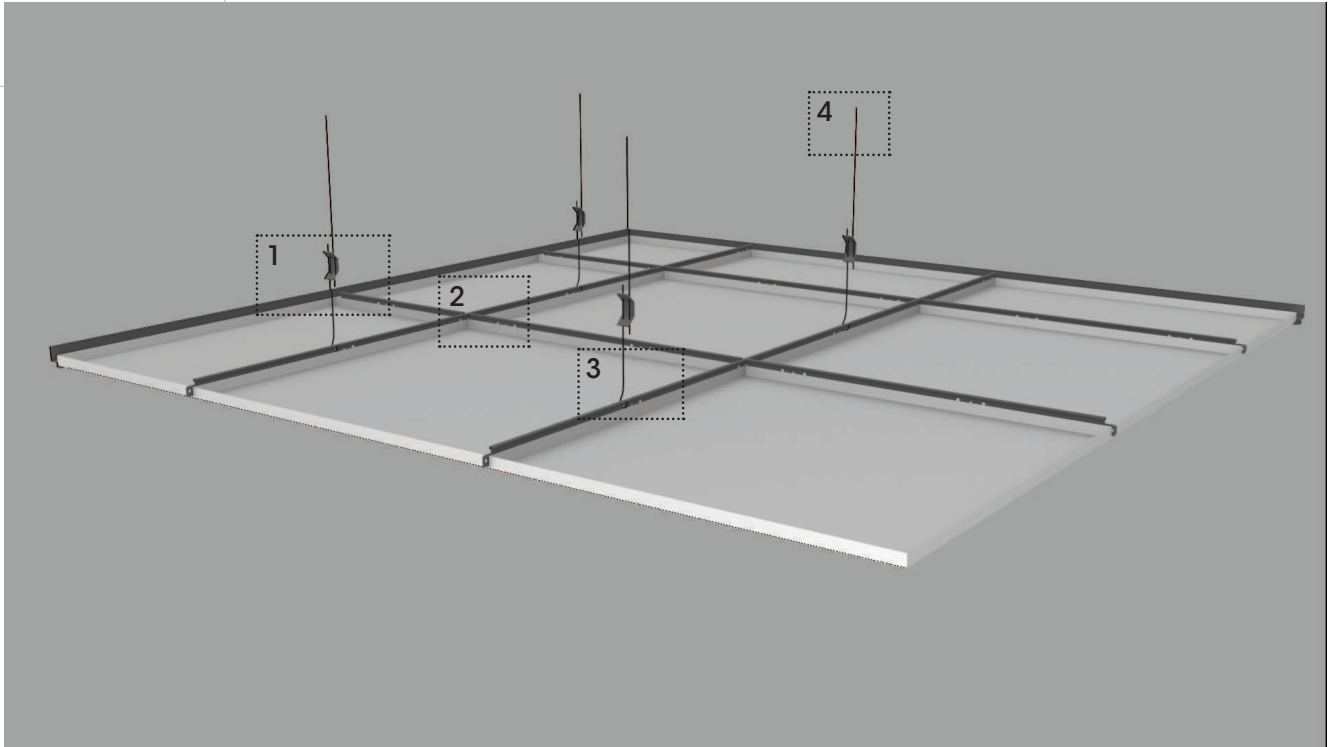

**Lay-in Tile Flat**

Integra Tile Lay-in Flat tavan sistemleri sarkmasız olarak çeşitli T-24 taşıyıcı sistemlerine uyum sağlar. Diğer tüm Lay-in sistemleri gibi Lay-in Flat panelleri de herhangi bir sökme elemanı kullanılmasına gerek kalmadan kolayca sökülebilir.

Standart Panel / Standard Panel

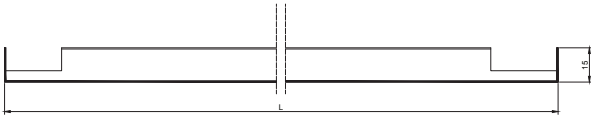
**Panel Tanımı**

**Hammadde:** Galvanize çelik, Paslanmaz çelik, Alüminyum.

**Kenar özelliği:** Küt

**En:** 600 mm

**Boy:** 600mm

**Boya:** RAL 9006, RAL 9010, RAL 9016

- . İsteğe bağlı olarak tüm RAL renklerinde üretim yapılabilir.
- . Özellikle hijyen gerektiren alanlar için anti bakteriyel boya seçeneği mevcuttur.
- . İstenildiğinde ahşap görümlü paneller üretilebilir.
- . Daha fazla bilgi için bkz. **Renk ve Desen**

**Perforasyon:** Ø0.7, Ø1.5, Ø1.8, Ø2.5, Ø3, Ø4.5, Ø6, Ø7, Ø16, 8x8, Random

- . Daha fazla bilgi için bkz. **Perforasyon**

**Akustik:** NRC 0,70(Ø2.5mm %16 boşluk oranı)  
Daha fazla bilgi için bkz. **Akustik**

**Yangın:** Yangın tepki sınıfı A2-s1,d0.  
Daha fazla bilgi için bkz. **Standartlar**

**Teknik Standartlar:**

- . T24 taşıyıcı sistem ile desteklenen paneller, ISO9001:2008, TSE ve CE belgeli tesisimizde Avrupa, Amerika ve TAIM (Technical Association of Industrial Metal Ceiling Manufacturers) standartlarına uygun olarak imal edilmektedir.
- . Malzemenin yangın tepki sınıfı, uluslar arası akredite edilmiş test kuruluşlarında yaptırılmış yangın testi ile EN 13501-1 standardı uyarınca yapılan sınıflandırma sonucu A2-s1,d0 olarak belgelenmiştir.

**Lay-in Tile Flat**

Integra Tile Lay-in Flat panels are fully compatible with various T-24 suspension systems As with all other Lay-in systems, Lay-in Flat panels can also be easily demounted without the need for tools.

Standart Birleşim / Standard Connection

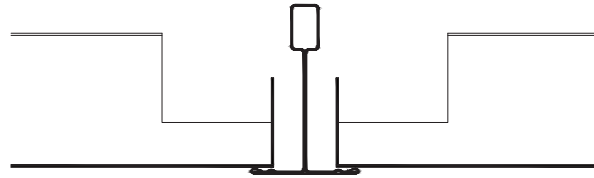
**Panel Description**

**Raw material:** Galvanized Steel, Stainless Steel, Aluminium.

**Edge Option:** Square

**Width:** 600 mm

**Length:** 600 mm

**Colour:** RAL9006, RAL9010, RAL9016

- . Production is possible in all other RAL colours upon request.
- . Antibacterial paint option is available upon request, especially for areas with hygiene requirements.
- . Panels with wood appearance can be produced if requested.
- . For detailed information please see **Colours and Design**.

**Perforation:** Ø0.7, Ø1.5, Ø1.8, Ø2.5, Ø3, Ø4.5, Ø6, Ø7, Ø16, 8x8, Random

For detailed information please see **Perforation**.

**Acoustics:** NRC: 0,70(Ø2.5mm %16 open area)  
For detailed information please see **Acoustics**.

**Fire:** Reaction to Fire Class A2-s1,d0.  
For detailed information please see **Standards**.

**Technical Standards:**

- . Ceiling panels supported by T-24 suspension system manufactured in accordance with European, American and TAIM (Technical Association of Industrial Metal Ceiling Manufacturers) standards in our factory that have ISO9001:2008, TSE ve CE certificates.
- . Panels are tested in accordance with EN 13501-1 and must be designed to comply with Euroclass A2-s1, d0

## METAL CEILING SPECIFICATION

... x ... mm Sized Flat Lay-in Standard System

### General Description:

Aluminium /Stainless Steel/ Galvanised Steel ceiling panels supported by T-24 suspension system manufactured in accordance with European, American and (Technical Association of Industrial Metal Ceiling Manufacturers) standards by a manufacturer that have ISO9001:2008, TSE ve CE certificates.

Ceilings are tested in accordance with EN 13501-1 and must be designed to comply with at least Euroclass A2-s1, d0

### Panel Description:

- Raw material:** Ceiling panels manufactured from ... mm Aluminium /Stainless Steel/ Galvanised Steel  
**Colour:** Ceiling panels coated electrostatically applied powder coating coloured RAL ... ( min. 40  $\mu$  thickness and approx. %20 Gloss Rate)  
**Acoustical inlay:** Ceiling panels are manufactured with 0,2 mm thickness, black acoustical inlay (Royalin / Soundtex) to achieve sound absorption  $\alpha_w = \dots$  for  $\varnothing \dots$  mm Perforation (%.. open area)  
**Perforation:** Ceiling panels are perforated  $\varnothing \dots$  mm (% ... open area) and plain borders are ... mm.  
**Edge:** Square

### Installation:

C Wall Angle (4) (Shadow Angle /L Wall Angle) should be used for lateral sides facing inwards of the gypsum pool. The first hanger system (Grida-T24) should not exceed 450 mm distance from the wall and the distance between hangers could be max 1000mm. Double spring clip(5), hanger wire(6) and steel anchor(7) will be used to suspend the runners securely. The distance between Wall-angle and the T-24 main runner should be max. 600 mm. The distance between the T-24 main runners should not exceed 1200mm. The T-24 cross runners should be positioned on 600 mm away from each. Lighting, sprinkler or vent places should be cutted out and the components should be mounted according to the project after the installation. In the case of these components come up to suspension system accessories, installation should be continued with mounting suspension system accesories one before and one after the components.

### Suspension System:

- 1- **AS GR24-BO1:** T-24 Main Runner, 3600 mm length, 0,4 mm thickness , galvanised steel.
- 2- **AS GR24-BO2:** T-24 Cross Tee Runner, 1200 mm length, 0,4 mm thickness , galvanised steel.
- 3- **AS GR24-BO3:** T-24 Cross Tee Runner, 600 mm length, 0,4 mm thickness , galvanised steel.
- 4- **CDPR 300:** C-Wall Angle, 20x40x20 mm sized, 3000 mm length, 0,5 mm thickness, pre-painted galvanised steel
- 5- **KT 40:** Wedge Clip, 0,5 mm thickness, galvanised steel
- 6- **HDVC/4:** Double spring clip, black colored, phosphatized, 0,5 mm thickness, galvanised steel
- 7- **DST-01:** Hanger Wire,  $\varnothing 4$  mm, 1000mm length (Standard)
- 8- **TP-02:** Steel anchor that coated by zinc against corrosion

PANEL BAĞLANTI DETAYLARI  
PANEL CONNECTION DETAILS

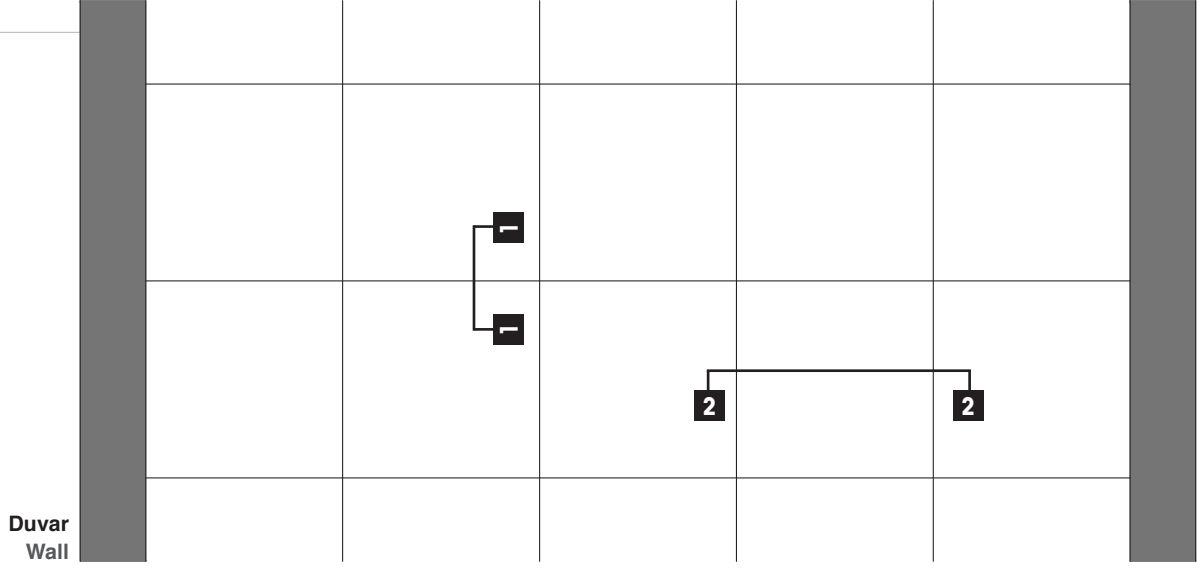

1-1 Kesiti / Section 1-1

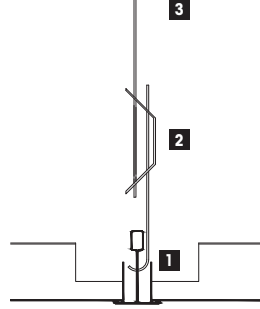

Taşıyıcı - Panel Birleşimi

- 1 T-24 Ana Taşıyıcı
- 2 Askı Yayı
- 3 Askı Teli

Profile - Panel Connection

- 1 T-24 Main Runner
- 2 Double Spring Clip
- 3 Hanger Wire

2-2 Kesiti / Section 2-2

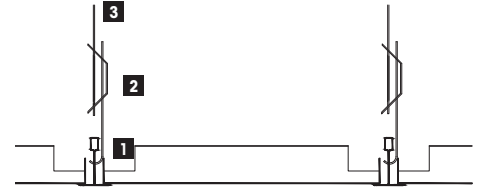

Panel Birleşimi

- 1 T-24 Ana Taşıyıcı
- 2 Askı Yayı
- 3 Askı Teli

Connection of Panels

- 1 T-24 Main Runner
- 2 Double Spring Clip
- 3 Hanger Wire

METAL VE DİĞER TAVANLARIN BİRLEŞİM DETAYLARI  
METAL AND OTHER CEILING CONNECTION DETAILS

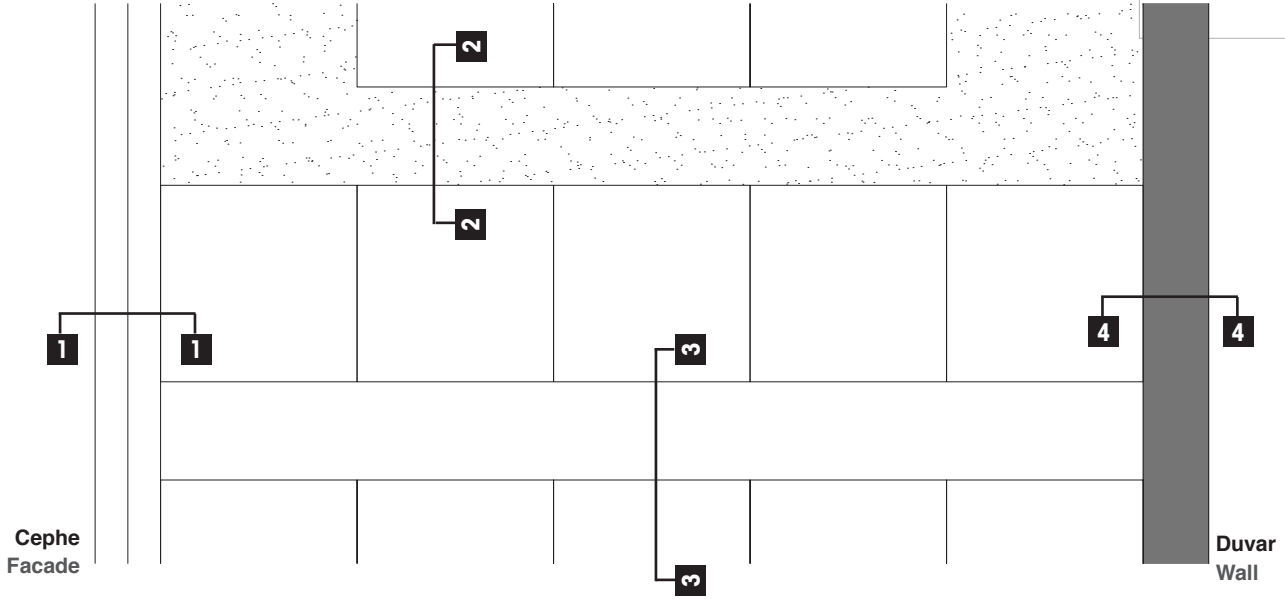

1-1 Kesiti / Section 1-1

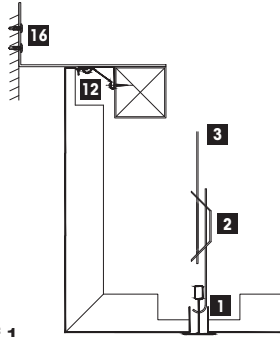

Alternatif 1

Yarım Clip-in Profil ile Alın Panel Bitişi
1 T-24 Ana Taşıyıcı
2 Askı Yayı
3 Askı Teli
12 Yarım Clip-in Profil
16 Duvar Bağlantı Pabucu

Alternative 1

L Panel Finish with Half Clip-in Profile
1 T-24 Main Runner
2 Double Spring Clip
3 Hanger Wire
12 Half Clip-in Profile
16 Wall Anchor

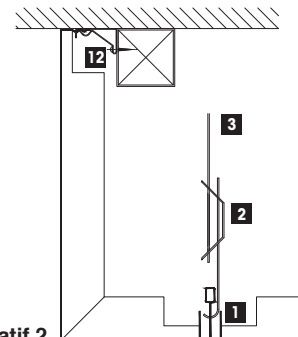

Alternatif 2

Yarım clip-in Profil ile Alın Panel Bitişi
1 T-24 Ana Taşıyıcı
2 Askı Yayı
3 Askı Teli
12 Yarım Clip-in Profil

Alternative 2

L Panel Finish with Clip-in Profile
1 T-24 Main Runner
2 Double Spring Clip
3 Hanger Wire
12 Half Clip-in Profile

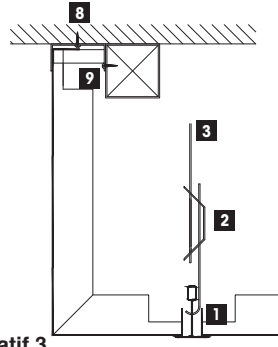

Alternatif 3

C köşebent ile Alın Panel Bitişi
1 T-24 Ana Taşıyıcı
2 Askı Yayı
3 Askı Teli
8 C Köşebent
9 Kenar Takozu

Alternative 3

L Panel Finish with C Wall Angle
1 T-24 Main Runner
2 Double Spring Clip
3 Hanger Wire
8 C Wall Angle
9 Wedge Clip

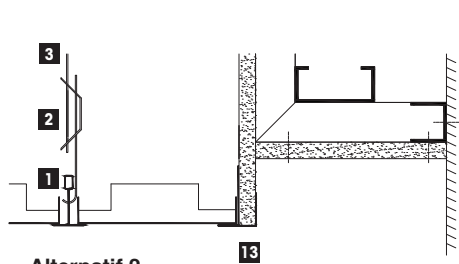

Alternatif 2

F Profil ile Alçıpan - Metal Tavan Birleşimi
1 T-24 Ana Taşıyıcı
2 Askı Yayı
3 Askı Teli
13 F Profil

Alternative 2

Joint to a Gypsum Board with F Profile
1 T-24 Main Runner
2 Double Spring Clip
3 Hanger Wire
13 F Profile

2-2 Kesiti / Section 2-2

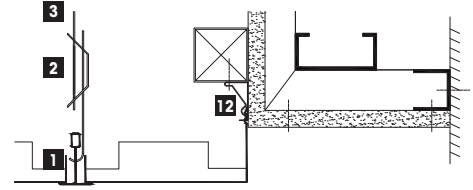

Alternatif 1

Yarım Clip-in Profil ile Alçıpan - Metal Tavan Birleşimi
1 T-24 Ana Taşıyıcı
2 Askı Yayı
3 Askı Teli
12 Yarım Clip-in Profil

Alternative 1

Joint to a Gypsum Board with Half Clip-in Profile
1 T-24 Main Runner
2 Double Spring Clip
3 Hanger Wire
12 Half Clip-in Profile

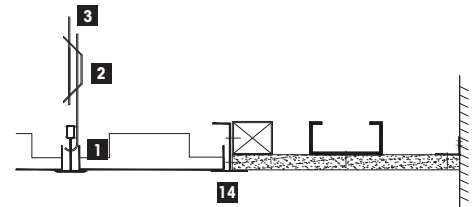

Alternatif 3

H Profil ile Alçıpan - Metal Tavan Birleşimi
1 T-24 Ana Taşıyıcı
2 Askı Yayı
3 Askı Teli
14 H Profil

Alternative 3

Joint to a Gypsum Board with H Profile
1 T-24 Main Runner
2 Double Spring Clip
3 Hanger Wire
14 H Profile

3-3 Kesiti / Section 3-3



Alternatif 1

Kapama Paneli - Metal Tavan Birleşimi

- 1 T-24 Ana Taşıyıcı
- 2 Askı Yay
- 3 Askı Teli

Alternative 1

Joint to Metal Ceiling with Covering Panel

- 1 T-24 Main Runner
- 2 Double Spring Clip
- 3 Hanger Wire

4-4 Kesiti / Section 4-4

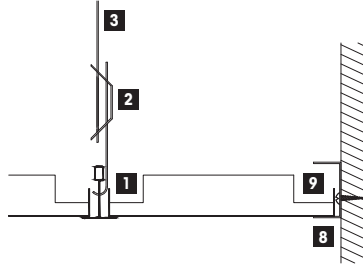

Alternatif 1

C Köşebent ile Tam Plaka Duvar Bitişi

- 1 T-24 Ana Taşıyıcı
- 2 Askı Yay
- 3 Askı Teli
- 8 C Köşebent
- 9 Kenar Takozu

Alternative 1

Full Panel Finish with C Wall Angle

- 1 T-24 Main Runner
- 2 Double Spring Clip
- 3 Hanger Wire
- 8 C Wall Angle
- 9 Wedge Clip

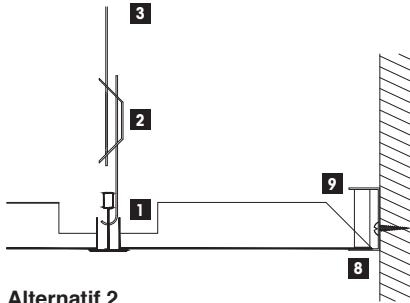

Alternatif 2

C Köşebent ile Kesik Plaka Duvar Bitişi

- 1 T-24 Ana Taşıyıcı
- 2 Askı Yay
- 3 Askı Teli
- 8 C Köşebent
- 9 Kenar Takozu

Alternative 2

Cutted Panel Finish with C Wall Angle

- 1 T-24 Main Runner
- 2 Double Spring Clip
- 3 Hanger Wire
- 8 C Wall Angle
- 9 Wedge Clip

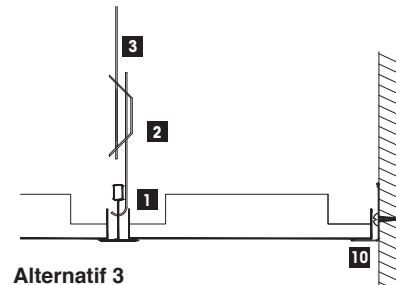

Alternatif 3

L Köşebent ile Tam Plaka Duvar Bitişi

- 1 T-24 Ana Taşıyıcı
- 2 Askı Yay
- 3 Askı Teli
- 10 L Köşebent

Alternative 3

Full Panel Finish with L Wall Angle

- 1 T-24 Main Runner
- 2 Double Spring Clip
- 3 Hanger Wire
- 10 L Wall Angle

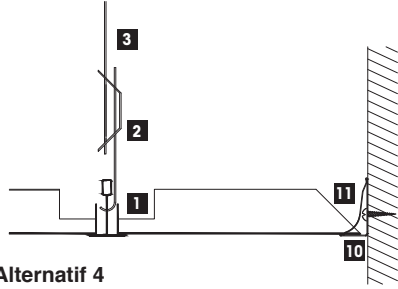

**Alternatif 4****L Köşebent ile Kesik Plaka Duvar Bitişi**

- |                            |
|----------------------------|
| <b>1</b> T-24 Ana Taşıyıcı |
| <b>2</b> Askı Yayı         |
| <b>3</b> Askı Teli         |
| <b>10</b> L Köşebent       |
| <b>11</b> Kenar Takozu     |

**Alternative 4****Cutted Panel Finish with L Wall Angle**

- |                             |
|-----------------------------|
| <b>1</b> T-24 Main Runner   |
| <b>2</b> Double Spring Clip |
| <b>3</b> Hanger Wire        |
| <b>10</b> L Wall Angle      |
| <b>11</b> Wedge Clip        |

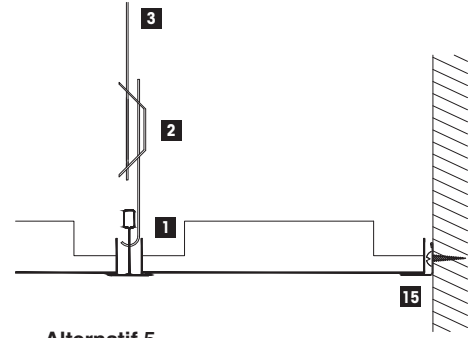
**Alternatif 5****Grıda L Köşebent ile Tam Plaka Duvar Bitişi**

- |                            |
|----------------------------|
| <b>1</b> T-24 Ana Taşıyıcı |
| <b>2</b> Askı Yayı         |
| <b>3</b> Askı Teli         |
| <b>15</b> Grıda L Köşebent |

**Alternative 5****Full Panel Finish with Grıda L Wall Angle**

- |                              |
|------------------------------|
| <b>1</b> T-24 Main Runner    |
| <b>2</b> Double Spring Clip  |
| <b>3</b> Hanger Wire         |
| <b>15</b> Grıda L Wall Angle |

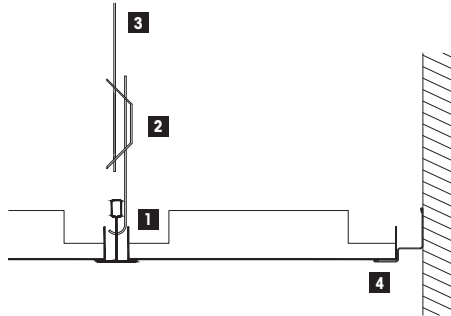
**Alternatif 6****Basamaklı Köşebent ile Tam Plaka Duvar Bitişi**

- |                             |
|-----------------------------|
| <b>1</b> T-24 Ana Taşıyıcı  |
| <b>2</b> Askı Yayı          |
| <b>3</b> Askı Teli          |
| <b>4</b> Basamaklı Köşebent |

**Alternative 6****Full Panel Finish with Z Profile**

- |                             |
|-----------------------------|
| <b>1</b> T-24 Main Runner   |
| <b>2</b> Double Spring Clip |
| <b>3</b> Hanger Wire        |
| <b>4</b> Z Wall Angle       |

CUTOUT YAPILMIŞ PANEL DETAYLARI  
PANELS WITH CUT-OUT DETAILS

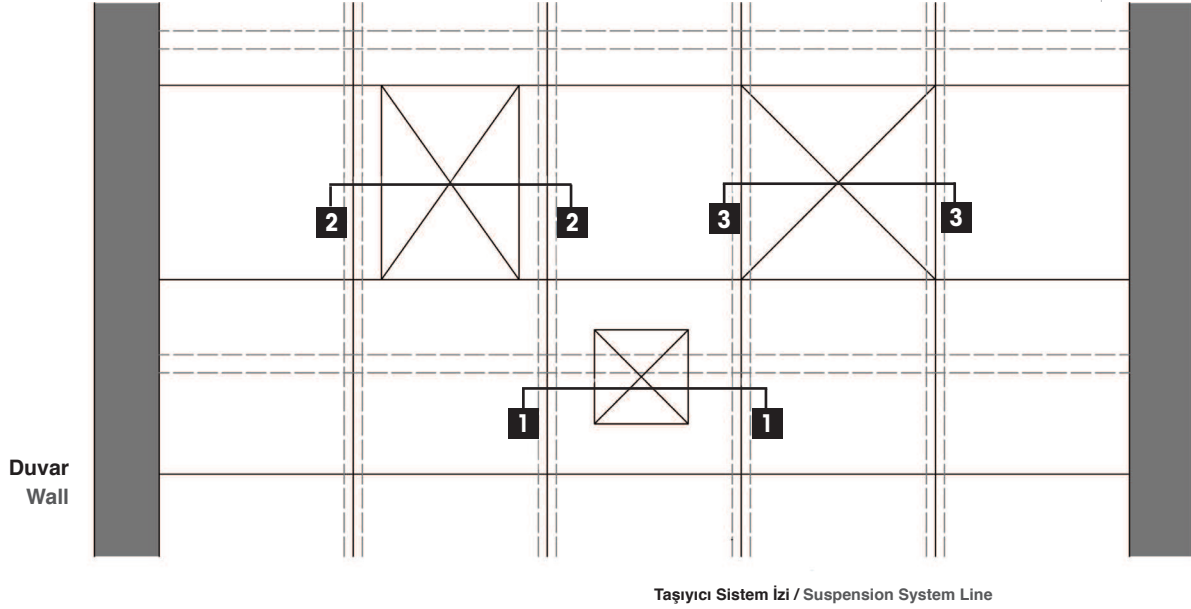

1-1 Kesiti / Section 1-1



2-2 Kesiti / Section 1-1

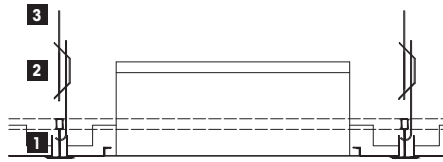

Cut-out Yapılmış Tavan Paneli

1 T-24 Ana Taşıyıcı

2 Askı Yayı

3 Askı Teli

Ceiling Panel with Cut-out

1 T-24 Main Runner

2 Double Spring Clip

3 Hanger Wire

Cut-out Yapılmış Tavan Paneli

1 T-24 Ana Taşıyıcı

2 Askı Yayı

3 Askı Teli

Ceiling Panel with Cut-out

1 T-24 Main Runner

2 Double Spring Clip

3 Hanger Wire

3-3 Kesiti / Section 3-3

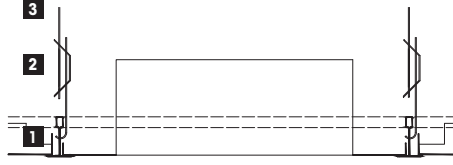

Cut-out Yapılmış Tavan Paneli

1 T-24 Ana Taşıyıcı

2 Askı Yayı

3 Askı Teli

Ceiling Panel with Cut-out

1 T-24 Main Runner

2 Double Spring Clip

3 Hanger Wire

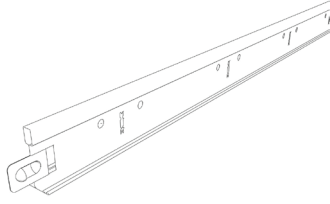

01

<b>AS-GR24-B01</b>	
Ürün Adı Özellik / Malzeme	T24 Ana Taşıyıcı 24x38x3600x0,4mm Galvanize Çelik 0,4 mm

<b>AS-GR24-B01</b>	
Product Reference Specification / Material	T24 Main Runner 24x38x3600x0,4mm Galvanized Steel 0,4 mm

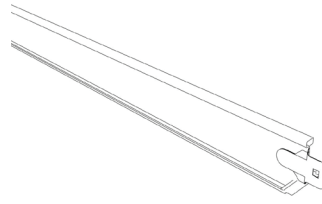

02

<b>AS-GR24-B02</b>	
Ürün Adı Özellik / Malzeme	T24 Tali Taşıyıcı 24x30x1200x0,4mm Galvanize Çelik 0,4 mm

<b>AS-GR24-B02</b>	
Product Reference Specification / Material	T24 Cross Runner 24x30x1200x0,4mm Galvanized Steel 0,4 mm

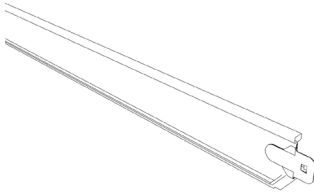

03

<b>AS-GR24-B03</b>	
Ürün Adı Özellik / Malzeme	T24 Tali Taşıyıcı 24x30x600x0,4mm Galvanize Çelik 0,4 mm

<b>AS-GR24-B03</b>	
Product Reference Specification / Material	T24 Cross Runner 24x30x600x0,4mm Galvanized Steel 0,4 mm

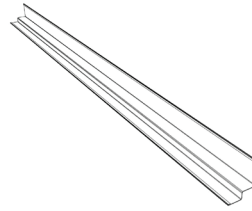

04

<b>AS-GR1508-B05</b>	
Ürün Adı Özellik / Malzeme	Basamaklı Köşebent 25x8x15x15x3050x0,5 mm Galvanize Çelik 0,5 mm

<b>AS-GR1508-B05</b>	
Product Reference Specification / Material	Z Wall Angle 25x8x15x15x3050x0,5 mm Galvanized Steel 0,5 mm



05

<b>HDVC/4</b>	
Ürün Adı Özellik / Malzeme	Askı Yay Yay Çeliği 0,5 mm

<b>HDVC/4</b>	
Product Reference Specification / Material	Double Spring Clip Spring Steel 0,5 mm



06

<b>DST 01</b>	
Ürün Adı Özellik / Malzeme	Askı Teli Galvanize Çelik 0,6 mm

<b>DST 01</b>	
Product Reference Specification / Material	Hanger Wire Galvanized Steel 0,6 mm

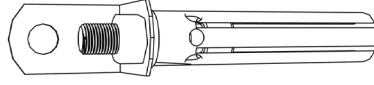

07

TP 02	
Ürün Adı Özellik / Malzeme	Çelik Dübelli Pabuç Yay Çeliği 2 mm
TP 02	
Product Reference Specification / Material	Steel Anchor Spring Steel 2,0 mm

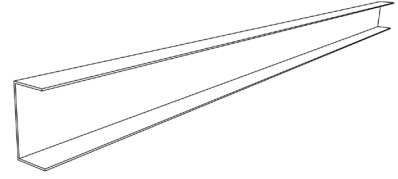

08

CDPR 300	
Ürün Adı Özellik / Malzeme	C Köşebent 20x40x20x3000x0,5 Galvanize Çelik 0,5 mm
CDPR 300	
Product Reference Specification / Material	C Wall Angle 20x40x20x3000x0,5 Galvanized Steel 0,5 mm

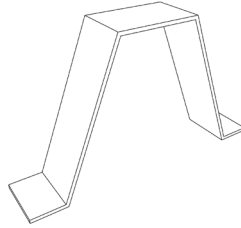

09

KT 40	
Ürün Adı Özellik / Malzeme	Kenar Takozu Yay Çeliği 0,45 mm
KT 40	
Product Reference Specification / Material	Wedge Clip Spring Steel 0,45 mm

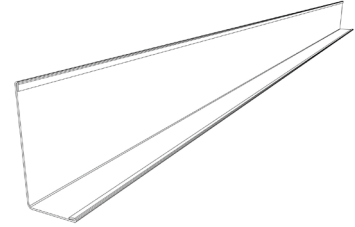

10

WL 3000	
Ürün Adı Özellik / Malzeme	L Köşebent 20x40x3000x0,5 Galvanize Çelik 0,5 mm
WL 3000	
Product Reference Specification / Material	L Wall Angle 20x40x3000x0,5 Galvanized Steel 0,5 mm



11

WKT 1	
Ordering Reference Specification / Material	Kenar Takozu Yay Çeliği 0,45 mm
WKT 1	
Ordering Reference Specification / Material	Wedge Clip Spring Steel 0,45 mm

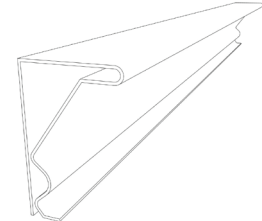

12

HCLN 400	
Ürün Adı Özellik / Malzeme	Yarım Clip-in Profil 18x29x4000x0,5 mm Galvanize Çelik 0,5 mm
HCLN 400	
Product Reference Specification / Material	Half Clip-in Profile 18x29x4000x0,5 mm Galvanized Steel 0,5 mm

13

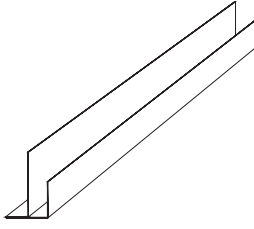

FDPR 3000	
Ordering Reference Specification / Material	F Profil Alüminyum 1 mm

FDPR 3000	
Ordering Reference Specification / Material	F Profile Aluminium 1 mm

14

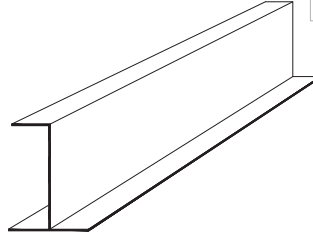

HDPR 40	
Ürün Adı Özellik / Malzeme	H Profil 30x40x3000x1mm Alüminyum 1 mm

HDPR 40	
Product Reference Specification / Material	H Profile 30x40x3000x1mm Aluminium 1 mm

15

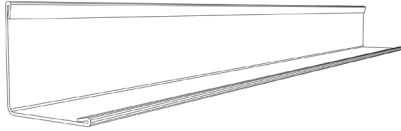

AS-GR1919-B04	
Ürün Adı Özellik / Malzeme	Grida L Profil 19x19x3050x0,5 mm Galvanize Çelik 0,5 mm

AS-GR1919-B04	
Product Reference Specification / Material	Grida L Wall Angle 19x19x3050x0,5 mm Galvanized Steel 0,5 mm

16

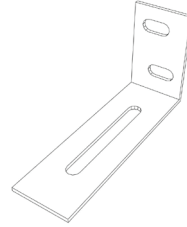

AS-30	
Ürün Adı Özellik / Malzeme	Duvar Bağlantı Pabucu Galvanize Çelik 1,5 mm 30x50x100x1,5 mm

AS-30	
Product Reference Specification / Material	Wall Anchor Galvanized Steel 1,5 mm 30x50x100x1,5