

BAFFLES

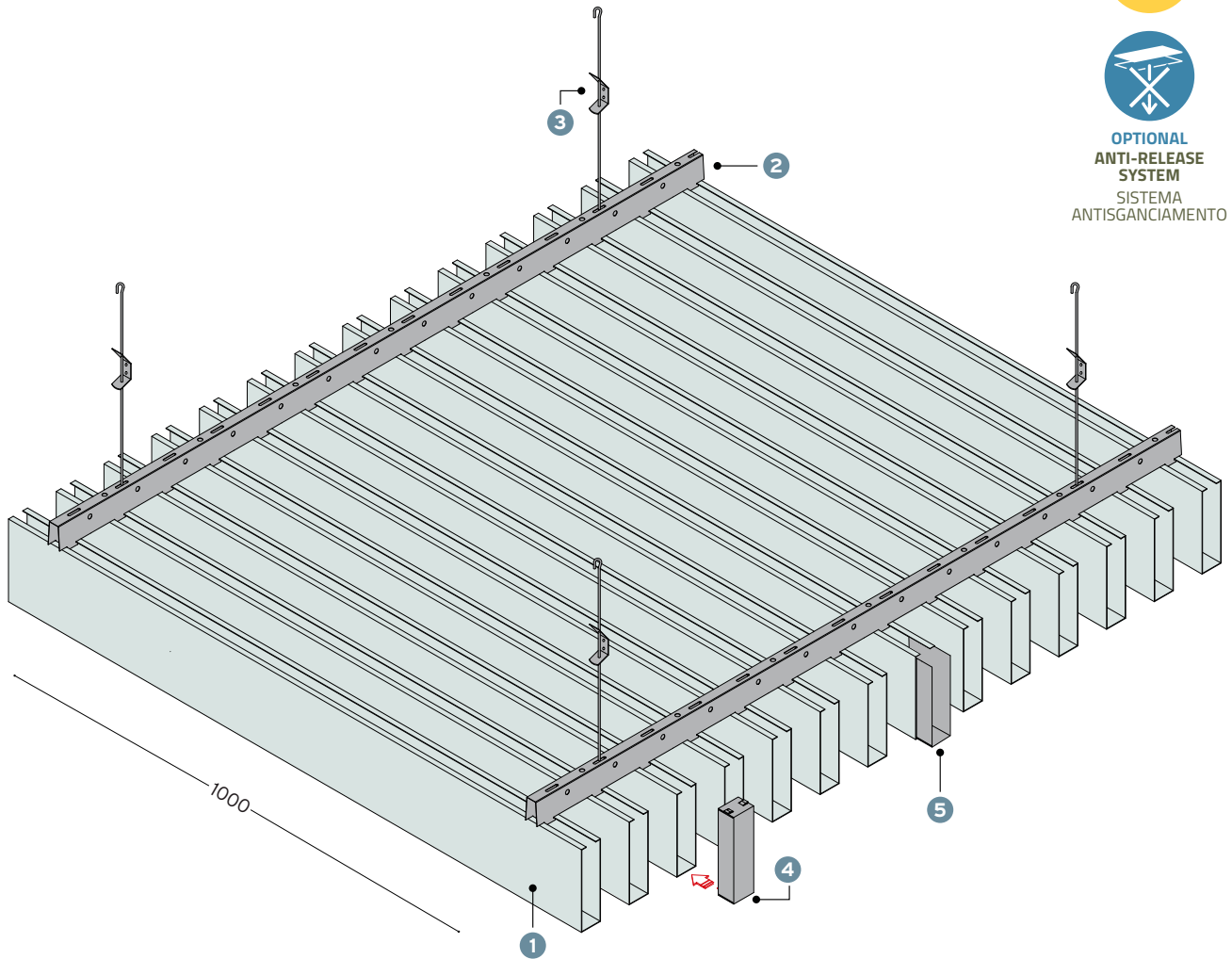

**OPTIONAL
ANTI-RELEASE
SYSTEM**
SISTEMA
ANTISGANCIAMENTO



STRIP DOGA

L 4000 mm max
· special length
on request
· dimensioni speciali
a richiesta

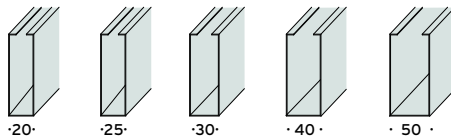

prepainted aluminium
alluminio preverniciato
thk sp. 0.5 > 0.8 mm

prepainted galvanized steel
acciaio zincato preverniciato
thk sp. 0.4 > 0.8 mm

powder coated aluminium
alluminio postverniciato
thk sp. 0.5 > 0.8 mm

powder coated steel
acciaio postverniciato
thk sp. 0.4 > 0.8 mm

MAIN RUNNER PROFILO PORTANTE

L 4000 mm

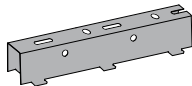

standard pitch passo standard:
40 mm

· different pitch on request
· varianti passo a richiesta

galvanized steel
acciaio zincato
thk sp. 0.6 mm

colour: black
colore: nero

optional: anti-release system
opzionale: sistema antisganciamento

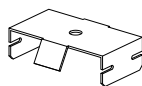

ESB 01/40 suspension adapter
for threaded bars
elemento di sospensione
per barra filettata

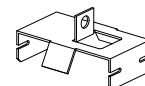

ESB 02/40 suspension adapter
for hanging brackets
elemento di sospensione
per pendino

1

strip
doga

2

carrier
profilo portante

3

adjustable suspension
sospensione regolabile

4











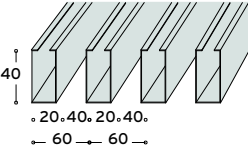
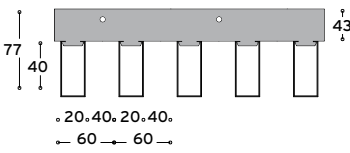

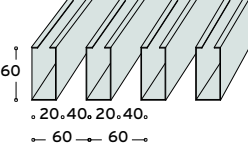
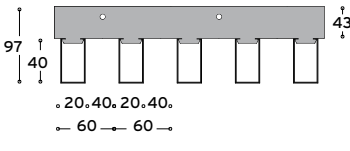
closing caps
chiusura terminale

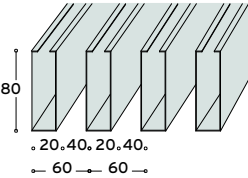
5

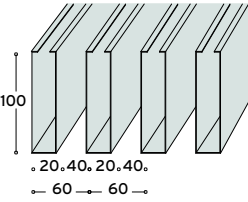
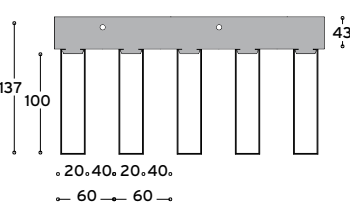
linear joint
giunto lineare

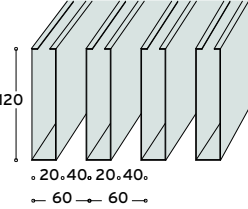
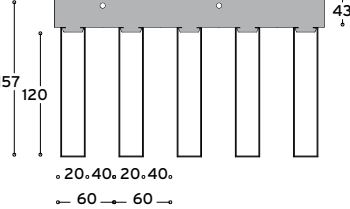
BASE 20 mm

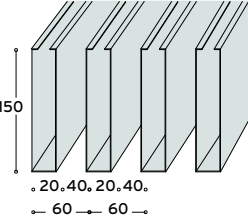
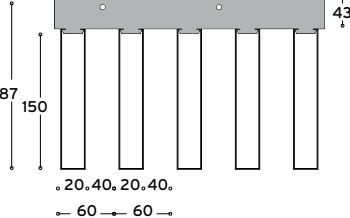
MAIN RUNNERS _ PROFILI PORTANTI

code _ codice	type _ tipo	code _ codice	thickness _ spessore	colour _ colore
ST020A0	metal strips pitch 60 mm doghe passo 60 mm	T UNI/X	galvanized steel acciaio zincato	black nero
	size dimensioni incidence incidenza 20x40 mm 16.67 ml/mq		thk sp. 0.6 mm	
			length lunghezza incidence incidenza 4000 mm 0.9 ml/mq	
			 pcs_pz : 10	
ST020A1	metal strips pitch 60 mm doghe passo 60 mm	T UNI/X	galvanized steel acciaio zincato	black nero
	size dimensioni incidence incidenza 20x60 mm 16.67 ml/mq		thk sp. 0.6 mm	
			length lunghezza incidence incidenza 4000 mm 0.9 ml/mq	
			 pcs_pz : 10	
ST020A2	metal strips pitch 60 mm doghe passo 60 mm	T UNI/X	galvanized steel acciaio zincato	black nero
	size dimensioni incidence incidenza 20x80 mm 16.67 ml/mq		thk sp. 0.6 mm	
			length lunghezza incidence incidenza 4000 mm 0.9 ml/mq	
			 pcs_pz : 10	
ST020A3	metal strips pitch 60 mm doghe passo 60 mm	T UNI/X	galvanized steel acciaio zincato	black nero
	size dimensioni incidence incidenza 20x100 mm 16.67 ml/mq		thk sp. 0.6 mm	
			length lunghezza incidence incidenza 4000 mm 0.9 ml/mq	
			 pcs_pz : 10	
ST020A4	metal strips pitch 60 mm doghe passo 60 mm	T UNI/X	galvanized steel acciaio zincato	black nero
	size dimensioni incidence incidenza 20x120 mm 16.67 ml/mq		thk sp. 0.6 mm	
			length lunghezza incidence incidenza 4000 mm 0.9 ml/mq	
			 pcs_pz : 10	
ST020A5	metal strips pitch 60 mm doghe passo 60 mm	T UNI/X	galvanized steel acciaio zincato	black nero
	size dimensioni incidence incidenza 20x150 mm 16.67 ml/mq		thk sp. 0.6 mm	
			length lunghezza incidence incidenza 4000 mm 0.9 ml/mq	
			 pcs_pz : 10	

closing caps in aluminium and steel · chiusura terminale alluminio e acciaio

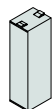

for per

ST020A0 > TAP 50/20

ST020A1 > TAP 60/20

ST020A2 > TAP 80/20

for per

ST020A3 > TAP 100/20

ST020A4 > TAP 120/20

ST020A5 > TAP 150/20



for per

ST020A0 > GL 40/20

ST020A1 > GL 60/20

ST020A2 > GL 80/20

for per

ST020A3 > GL 100/20





ST020A4 > GL 120/20

ST020A5 > GL 150/20

linear joint · giunto lineare aluminium alluminio 0.5 mm · L 500 mm

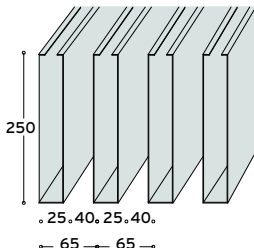
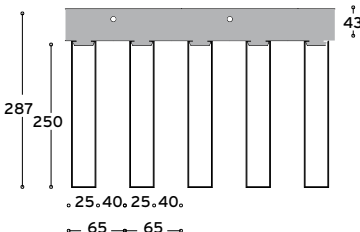
BASE 25 mm

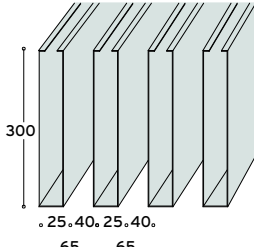
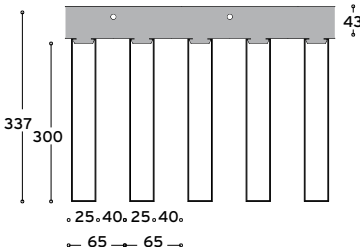
MAIN RUNNERS _ PROFILI PORTANTI

code _ codice	type _ tipo	code _ codice	thickness _ spessore	colour _ colore
ST025A7	metal strips pitch 65 mm doghe passo 65 mm	T UNI/X	galvanized steel acciaio zincato	black nero
	size dimensioni incidence incidenza 25x250 mm 15.40 ml/mq		thk sp. 0.6 mm	
			length lunghezza incidence incidenza 4000 mm 0.9 ml/mq	
			 pcs_pz : 10	
ST025A8	metal strips pitch 65 mm doghe passo 65 mm	T UNI/X	galvanized steel acciaio zincato	black nero
	size dimensioni incidence incidenza 25x300 mm 15.40 ml/mq		thk sp. 0.6 mm	
			length lunghezza incidence incidenza 4000 mm 0.9 ml/mq	
			 pcs_pz : 10	

closing caps in aluminium and steel · chiusura terminale alluminio e acciaio

linear joint · giunto lineare

aluminium alluminio 0.5 mm · L 500 mm



for per

ST025A1 › TAP 60/25
ST025A2 › TAP 80/25
ST025A3 › TAP 100/25
ST025A4 › TAP 120/25

for per

ST025A5 › TAP 150/25
ST025A6 › TAP 200/25
ST025A7 › TAP 250/25
ST025A8 › TAP 300/25



for per











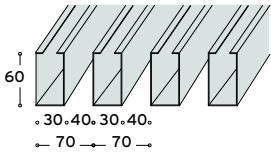
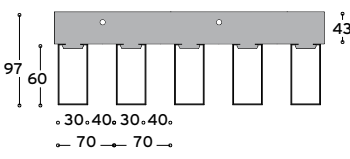

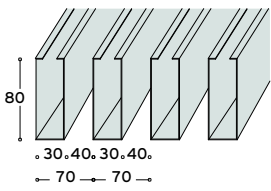
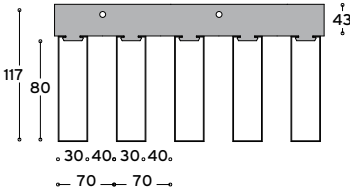
ST025A1 › GL 60/25
ST025A2 › GL 80/25
ST025A3 › GL 100/25
ST025A4 › GL 120/25

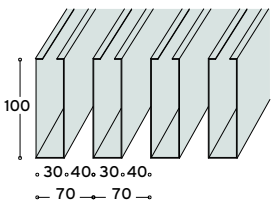
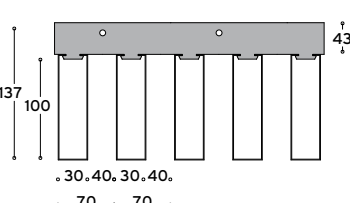
for per

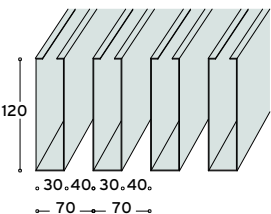
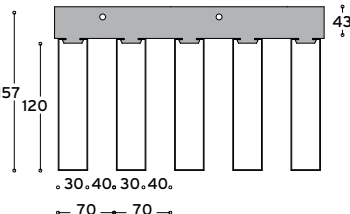
ST025A5 › GL 150/25
ST025A6 › GL 200/25
ST025A7 › GL 250/25
ST025A8 › GL 300/25

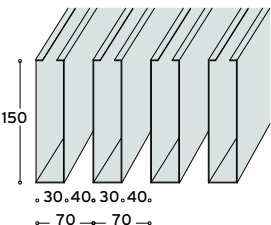
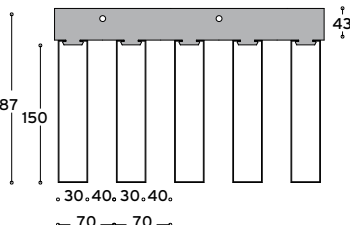
BASE 30 mm

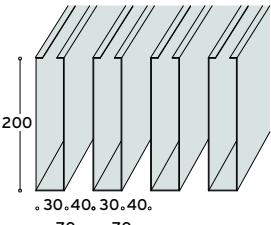
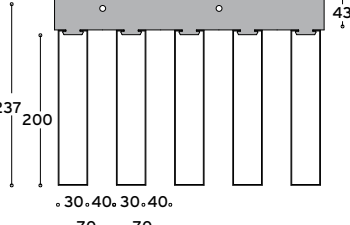
MAIN RUNNERS _ PROFILI PORTANTI

code _ codice	type _ tipo	code _ codice	thickness _ spessore	colour _ colore
ST030A1	metal strips pitch 70 mm doghe passo 70 mm	T UNI/X	galvanized steel acciaio zincato thk sp. 0.6 mm	black nero
	size dimensioni incidence incidenza 30x60 mm 14.30 ml/mq		length lunghezza incidence incidenza 4000 mm 0.9 ml/mq	 pcs_pz : 10
ST030A2	metal strips pitch 70 mm doghe passo 70 mm	T UNI/X	galvanized steel acciaio zincato thk sp. 0.6 mm	black nero
	size dimensioni incidence incidenza 30x80 mm 14.30 ml/mq		length lunghezza incidence incidenza 4000 mm 0.9 ml/mq	 pcs_pz : 10
ST030A3	metal strips pitch 70 mm doghe passo 70 mm	T UNI/X	galvanized steel acciaio zincato thk sp. 0.6 mm	black nero
	size dimensioni incidence incidenza 30x100 mm 14.30 ml/mq		length lunghezza incidence incidenza 4000 mm 0.9 ml/mq	 pcs_pz : 10
ST030A4	metal strips pitch 70 mm doghe passo 70 mm	T UNI/X	galvanized steel acciaio zincato thk sp. 0.6 mm	black nero
	size dimensioni incidence incidenza 30x120 mm 14.30 ml/mq		length lunghezza incidence incidenza 4000 mm 0.9 ml/mq	 pcs_pz : 10
ST030A5	metal strips pitch 70 mm doghe passo 70 mm	T UNI/X	galvanized steel acciaio zincato thk sp. 0.6 mm	black nero
	size dimensioni incidence incidenza 30x150 mm 14.30 ml/mq		length lunghezza incidence incidenza 4000 mm 0.9 ml/mq	 pcs_pz : 10
ST030A6	metal strips pitch 70 mm doghe passo 70 mm	T UNI/X	galvanized steel acciaio zincato thk sp. 0.6 mm	black nero
	size dimensioni incidence incidenza 30x200 mm 14.30 ml/mq		length lunghezza incidence incidenza 4000 mm 0.9 ml/mq	 pcs_pz : 10

BASE 30 mm

MAIN RUNNERS _ PROFILI PORTANTI

code _ codice type _ tipo code _ codice thickness _ spessore colour _ colore

ST030A7

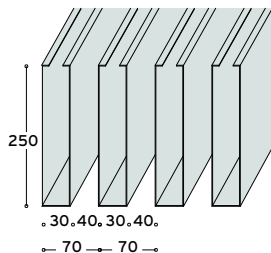

metal strips pitch 70 mm
doghe passo 70 mm

size	dimensioni	incidence	incidenza
30x250 mm		14.30 ml/mq	

T UNI/X

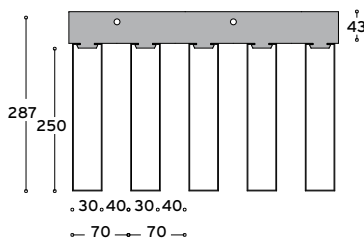

galvanized steel black
acciaio zincato nero
thk sp. 0.6 mm

length	lunghezza	incidence	incidenza
4000 mm		0.9 ml/mq	

pcs_pz : 10

ST030A8

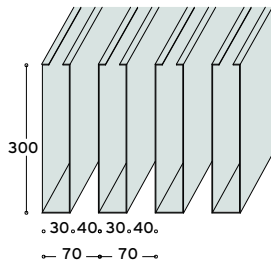

metal strips pitch 70 mm
doghe passo 70 mm

size	dimensioni	incidence	incidenza
30x300 mm		14.30 ml/mq	

T UNI/X

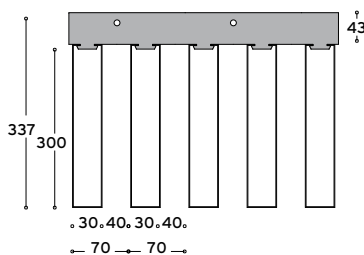

galvanized steel black
acciaio zincato nero
thk sp. 0.6 mm

length	lunghezza	incidence	incidenza
4000 mm		0.9 ml/mq	

pcs_pz : 10

closing caps in aluminium and steel · chiusura terminale alluminio e acciaio



for per

ST030A1 > TAP 60/30
ST030A2 > TAP 80/30
ST030A3 > TAP 100/30
ST030A4 > TAP 120/30

for per

ST030A5 > TAP 150/30
ST030A6 > TAP 200/30
ST030A7 > TAP 250/30
ST030A8 > TAP 300/30



for per

ST030A1 > GL 60/60
ST030A2 > GL 80/30
ST030A3 > GL 100/30
ST030A4 > GL 120/30

for per

ST030A5 > GL 150/30
ST030A6 > GL 200/30
ST030A7 > GL 250/30
ST030A8 > GL 300/30

linear joint · giunto lineare aluminium alluminio 0.5 mm · L 500 mm

BASE 40 mm

MAIN RUNNERS PROFILI PORTANTI

code _ codice	type _ tipo	code _ codice	thickness _ spessore	colour _ colore
ST040A1	metal strips pitch 80 mm doghe passo 80 mm	T UNI/X	galvanized steel acciaio zincato thk sp. 0.6 mm	black nero
	size dimensioni incidence incidenza 40x100 mm 12.50 ml/mq		length lunghezza incidence incidenza 4000 mm 0.9 ml/mq	
ST040A2	metal strips pitch 80 mm doghe passo 80 mm	T UNI/X	galvanized steel acciaio zincato thk sp. 0.6 mm	black nero
	size dimensioni incidence incidenza 40x150 mm 12.50 ml/mq		length lunghezza incidence incidenza 4000 mm 0.9 ml/mq	
ST040A3	metal strips pitch 80 mm doghe passo 80 mm	T UNI/X	galvanized steel acciaio zincato thk sp. 0.6 mm	black nero
	size dimensioni incidence incidenza 40x200 mm 12.50 ml/mq		length lunghezza incidence incidenza 4000 mm 0.9 ml/mq	
ST040A4	metal strips pitch 80 mm doghe passo 80 mm	T UNI/X	galvanized steel acciaio zincato thk sp. 0.6 mm	black nero
	size dimensioni incidence incidenza 40x200 mm 12.50 ml/mq		length lunghezza incidence incidenza 4000 mm 0.9 ml/mq	
ST040A5	metal strips pitch 80 mm doghe passo 80 mm	T UNI/X	galvanized steel acciaio zincato thk sp. 0.6 mm	black nero
	size dimensioni incidence incidenza 40x200 mm 12.50 ml/mq		length lunghezza incidence incidenza 4000 mm 0.9 ml/mq	

closing caps in aluminium and steel · chiusura terminale alluminio e acciaio

linear joint · giunto lineare

aluminium alluminio 0.5 mm · L 500 mm



for per

ST040A1 › TAP 100/40
ST040A2 › TAP 150/40
ST040A3 › TAP 200/40
ST040A4 › TAP 250/40
ST040A5 › TAP 300/40



for per

ST040A1 › GL 100/40
ST040A2 › GL 150/40
ST040A3 › GL 200/40
ST040A4 › GL 250/40
ST040A5 › GL 300/40

BASE 40 mm

MAIN RUNNERS PROFILI PORTANTI

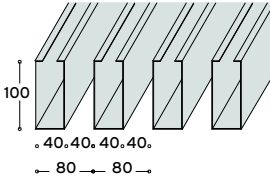
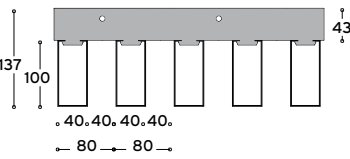
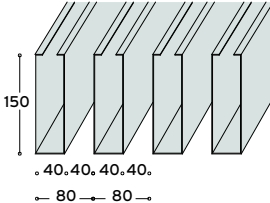
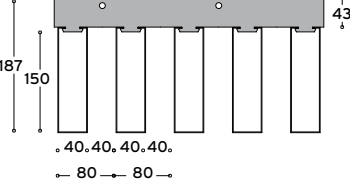
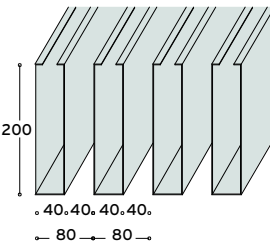
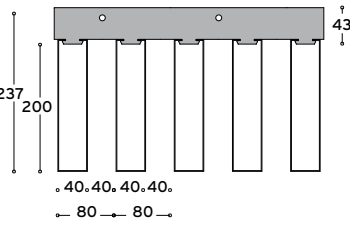
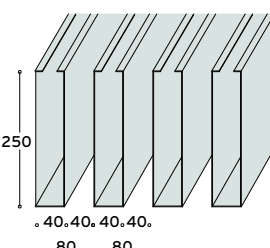
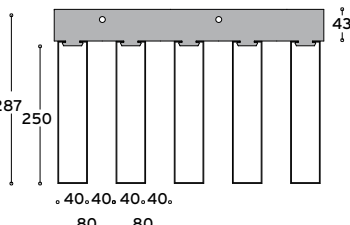
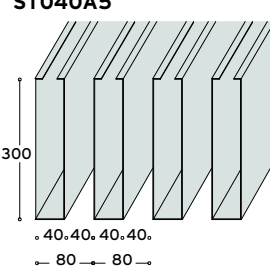
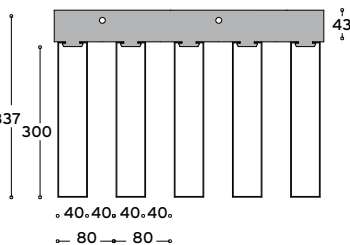
code _ codice	type _ tipo	code _ codice	thickness _ spessore	colour _ colore
ST040A1	metal strips pitch 80 mm doghe passo 80 mm	T UNI/X	galvanized steel acciaio zincato	black nero
	size dimensioni incidence incidenza 40x100 mm 12.50 ml/mq		thk sp. 0.6 mm	
			length lunghezza incidence incidenza 4000 mm 0.9 ml/mq	pcs_pz : 10
ST040A2	metal strips pitch 80 mm doghe passo 80 mm	T UNI/X	galvanized steel acciaio zincato	black nero
	size dimensioni incidence incidenza 40x150 mm 12.50 ml/mq		thk sp. 0.6 mm	
			length lunghezza incidence incidenza 4000 mm 0.9 ml/mq	pcs_pz : 10
ST040A3	metal strips pitch 80 mm doghe passo 80 mm	T UNI/X	galvanized steel acciaio zincato	black nero
	size dimensioni incidence incidenza 40x200 mm 12.50 ml/mq		thk sp. 0.6 mm	
			length lunghezza incidence incidenza 4000 mm 0.9 ml/mq	pcs_pz : 10
ST040A4	metal strips pitch 80 mm doghe passo 80 mm	T UNI/X	galvanized steel acciaio zincato	black nero
	size dimensioni incidence incidenza 40x200 mm 12.50 ml/mq		thk sp. 0.6 mm	
			length lunghezza incidence incidenza 4000 mm 0.9 ml/mq	pcs_pz : 10
ST040A5	metal strips pitch 80 mm doghe passo 80 mm	T UNI/X	galvanized steel acciaio zincato	black nero
	size dimensioni incidence incidenza 40x200 mm 12.50 ml/mq		thk sp. 0.6 mm	
			length lunghezza incidence incidenza 4000 mm 0.9 ml/mq	pcs_pz : 10

closing caps in aluminium and steel · chiusura terminale alluminio e acciaio

for per

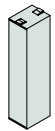
 **ST040A1** > TAP 100/40
ST040A2 > TAP 150/40
ST040A3 > TAP 200/40
ST040A4 > TAP 250/40
ST040A5 > TAP 300/40

linear joint · giunto lineare









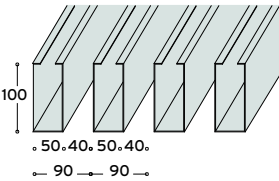
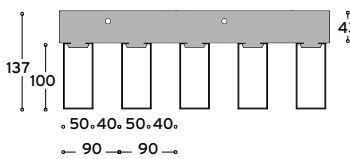

aluminium alluminio 0.5 mm · L 500 mm

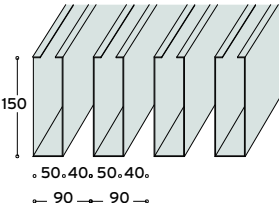
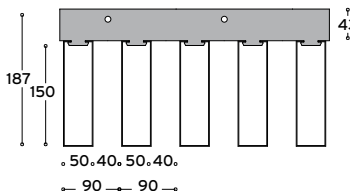
for per

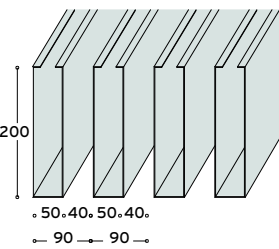
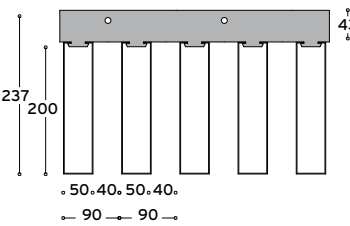
 **ST040A1** > GL 100/40
ST040A2 > GL 150/40
ST040A3 > GL 200/40
ST040A4 > GL 250/40
ST040A5 > GL 300/40

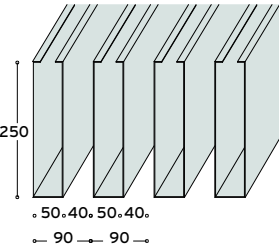
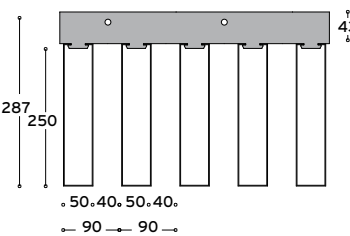
BASE 50 mm

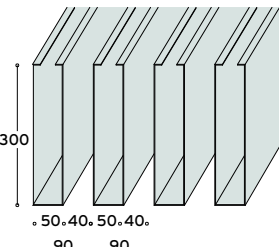
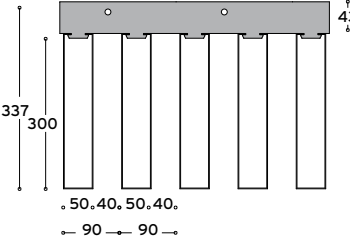
MAIN RUNNERS _ PROFILI PORTANTI

code _ codice	type _ tipo	code _ codice	thickness _ spessore	colour _ colore
ST050A1	metal strips pitch 90 mm doghe passo 90 mm	T UNI/X	galvanized steel acciaio zincato	black nero
	size dimensioni incidence incidenza 50x100 mm 11.11 ml/mq		thk sp. 0.6 mm	
			length lunghezza incidence incidenza 4000 mm 0.9 ml/mq	 pcs_pz : 10
ST050A2	metal strips pitch 90 mm doghe passo 90 mm	T UNI/X	galvanized steel acciaio zincato	black nero
	size dimensioni incidence incidenza 50x150 mm 11.11 ml/mq		thk sp. 0.6 mm	
			length lunghezza incidence incidenza 4000 mm 0.9 ml/mq	 pcs_pz : 10
ST050A3	metal strips pitch 90 mm doghe passo 90 mm	T UNI/X	galvanized steel acciaio zincato	black nero
	size dimensioni incidence incidenza 50x200 mm 11.11 ml/mq		thk sp. 0.6 mm	
			length lunghezza incidence incidenza 4000 mm 0.9 ml/mq	 pcs_pz : 10
ST050A4	metal strips pitch 90 mm doghe passo 90 mm	T UNI/X	galvanized steel acciaio zincato	black nero
	size dimensioni incidence incidenza 50x200 mm 11.11 ml/mq		thk sp. 0.6 mm	
			length lunghezza incidence incidenza 4000 mm 0.9 ml/mq	 pcs_pz : 10
ST050A5	metal strips pitch 90 mm doghe passo 90 mm	T UNI/X	galvanized steel acciaio zincato	black nero
	size dimensioni incidence incidenza 50x200 mm 11.11 ml/mq		thk sp. 0.6 mm	
			length lunghezza incidence incidenza 4000 mm 0.9 ml/mq	 pcs_pz : 10

closing caps in aluminium and steel · chiusura terminale alluminio e acciaio

linear joint · giunto lineare

aluminium alluminio 0.5 mm · L 500 mm

for per

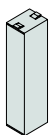

ST050A1 > TAP 100/50
ST050A2 > TAP 150/50
ST050A3 > TAP 200/50
ST050A4 > TAP 250/50
ST050A5 > TAP 300/50

for per



ST050A1 > GL 100/50
ST050A2 > GL 150/50
ST050A3 > GL 200/50
ST050A4 > GL 250/50
ST050A5 > GL 300/50

SQUARE BAFFLES



**OPTIONAL
ANTI-RELEASE
SYSTEM**
SISTEMA
ANTISGANCIAMENTO

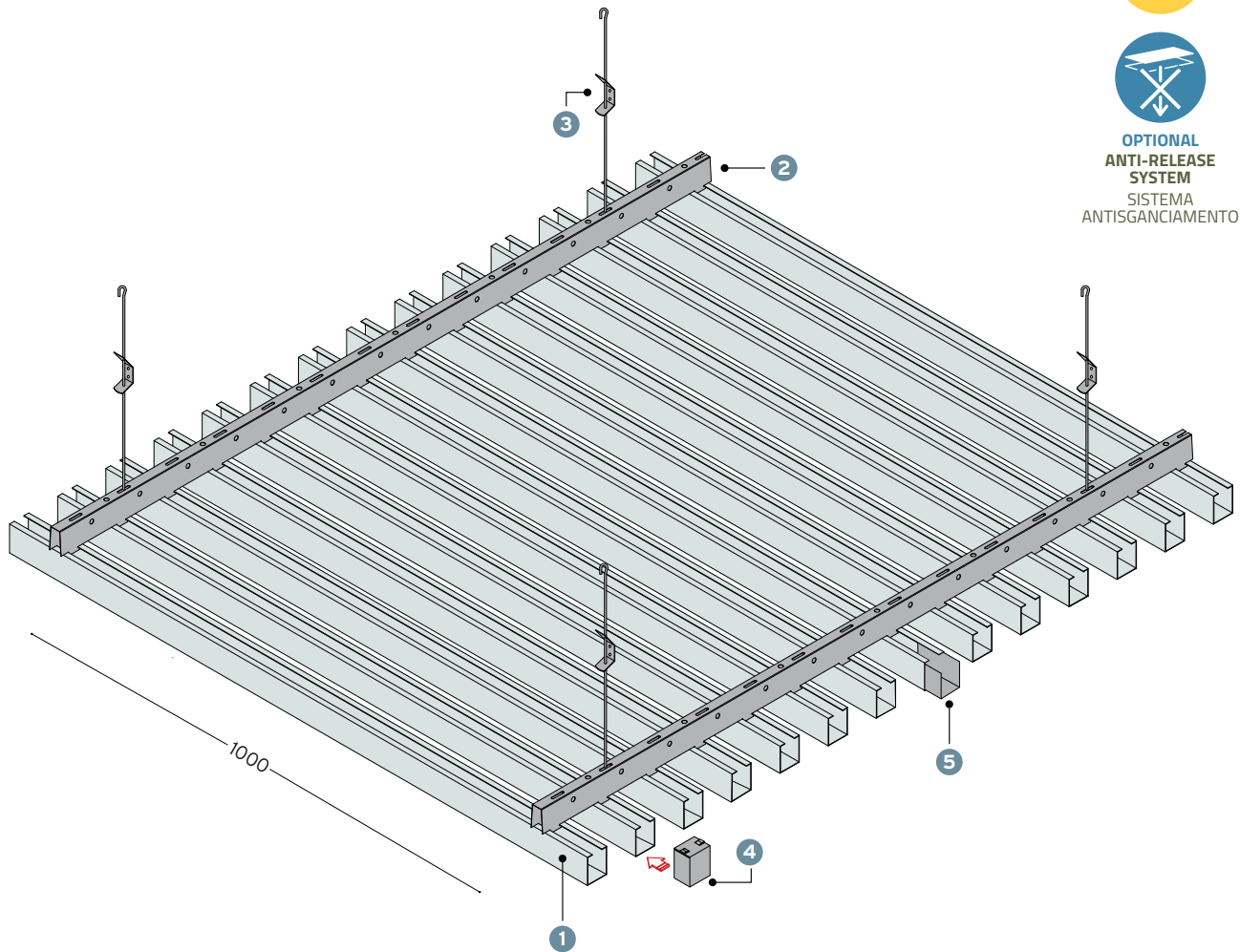

STRIP DOGA

L 4000 mm max

- special lenght on request
- dimensioni speciali a richiesta

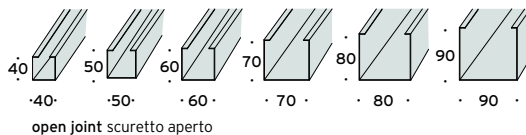

prepainted aluminium
alluminio preverniciato
thk sp. 0.6 - 0.7 - 0.8 mm

prepainted galvanized steel
acciaio zincato preverniciato
thk sp. 0.6 - 0.7 - 0.8 mm

powder coated aluminium
alluminio postverniciato
thk sp. 0.6 - 0.7 - 0.8 mm

powder coated steel
acciaio postverniciato
thk sp. 0.6 - 0.7 - 0.8 mm

MAIN RUNNER PROFILO PORTANTE

L 4000 mm

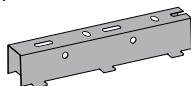

standard pitch passo standard:

40 mm

- different pitch on request
- varianti passo a richiesta

galvanized steel
acciaio zincato
thk sp. 0.6 mm

colour: black
colore: nero

optional: anti-release system
opzionale: sistema antisganciamento

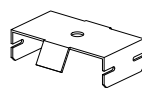

ESB 01/40 suspension adapter
for threaded bars
elemento di sospensione
per barra filettata

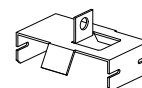

ESB 02/40 suspension adapter
for hanging brackets
elemento di sospensione
per pendino

1

strip
doga

2

carrier
profilo portante

3

adjustable suspension
sospensione regolabile

4





closing caps
chiusura terminale

5

linear joint
giunto lineare

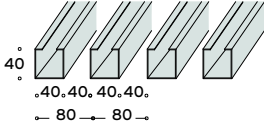
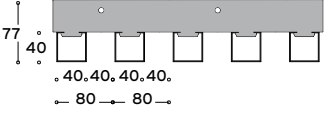
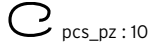
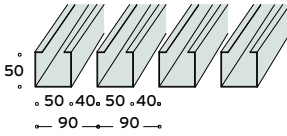
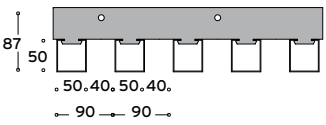
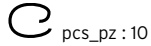
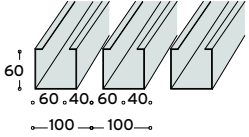
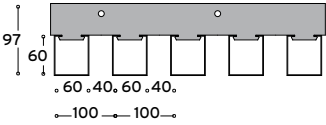
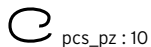
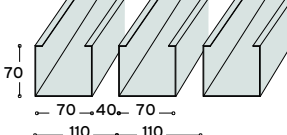
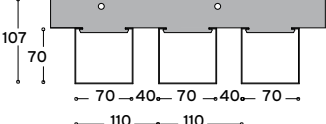
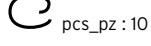
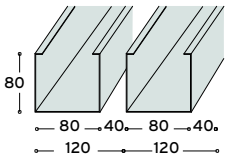
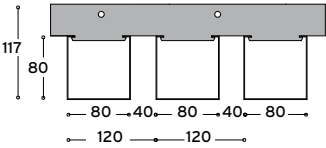
SQUARE BAFFLES

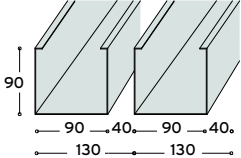
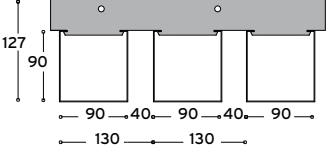
MAIN RUNNERS _ PROFILI PORTANTI

code _ codice	type _ tipo	code _ codice	thickness _ spessore	colour _ colore
ST4040	metal strips pitch 80 mm doghe passo 80 mm	T UNI/X	galvanized steel acciaio zincato thk sp. 0.6 mm	black nero
	size dimensioni incidence incidenza 40x40 mm 12.50 ml/mq		length lunghezza incidence incidenza 4000 mm 0.9 ml/mq	
ST5050	metal strips pitch 90 mm doghe passo 90 mm	T UNI/X	galvanized steel acciaio zincato thk sp. 0.6 mm	black nero
	size dimensioni incidence incidenza 50x50 mm 11.11 ml/mq		length lunghezza incidence incidenza 4000 mm 0.9 ml/mq	
ST6060	metal strips pitch 100 mm doghe passo 100 mm	T UNI/X	galvanized steel acciaio zincato thk sp. 0.6 mm	black nero
	size dimensioni incidence incidenza 60x60 mm 10.00 ml/mq		length lunghezza incidence incidenza 4000 mm 0.9 ml/mq	
ST7070	metal strips pitch 110 mm doghe passo 110 mm	T UNI/X	galvanized steel acciaio zincato thk sp. 0.6 mm	black nero
	size dimensioni incidence incidenza 70x70 mm 9.09 ml/mq		length lunghezza incidence incidenza 4000 mm 0.9 ml/mq	
ST8080	metal strips pitch 120 mm doghe passo 120 mm	T UNI/X	galvanized steel acciaio zincato thk sp. 0.6 mm	black nero
	size dimensioni incidence incidenza 80x80 mm 8.33 ml/mq		length lunghezza incidence incidenza 4000 mm 0.9 ml/mq	
ST9090	metal strips pitch 130 mm doghe passo 130 mm	T UNI/X	galvanized steel acciaio zincato thk sp. 0.6 mm	black nero
	size dimensioni incidence incidenza 90x90 mm 7.69 ml/mq		length lunghezza incidence incidenza 4000 mm 0.9 ml/mq	

closing caps in aluminium and steel · chiusura terminale alluminio e acciaio



for per

ST4040 > TAP 40/40
ST5050 > TAP 50/50
ST6060 > TAP 60/60
ST7070 > TAP 70/70
ST8080 > TAP 80/80
ST9090 > TAP 90/90

linear joint · giunto lineare

aluminium alluminio 0.5 mm · L 500 mm



for per

ST4040 > GL 40/40
ST5050 > GL 50/50
ST6060 > GL 60/60
ST7070 > GL 70/70
ST8080 > GL 80/80
ST9090 > GL 90/90

PERFORATION

standard width < 600 mm

● perforation

MICRO PERFORATION

H - AP0/1

Ø 0.7 mm - parallel pitch 5 mm

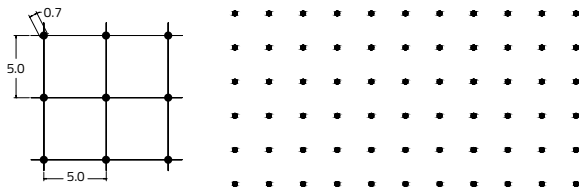

I - AP0/2

Ø 0.7 mm - parallel pitch 5 mm

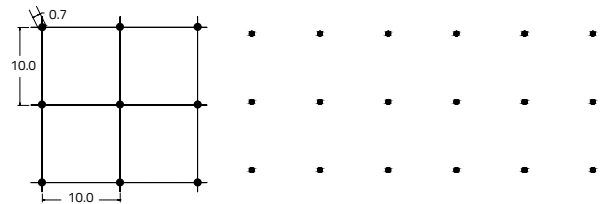

STANDARD PERFORATIONS

A

Ø 2.5 mm = 20% - parallel pitch 5 mm

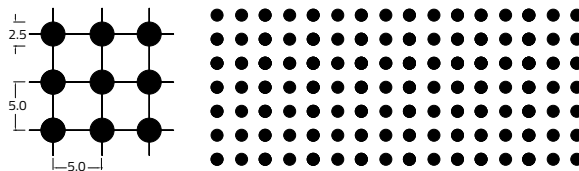

B

Ø 2.5 mm = 7% - diagonal pitch 8.5 mm

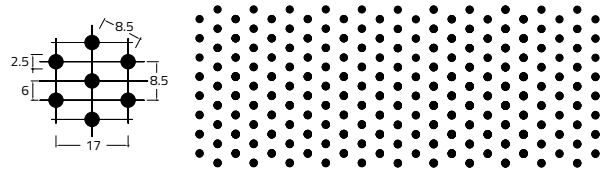

C

Ø 2.0 mm = 6% - diagonal pitch 8 mm

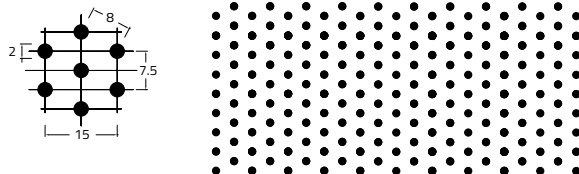

D

Ø 2.0 mm = 12% - parallel pitch 7.5 mm

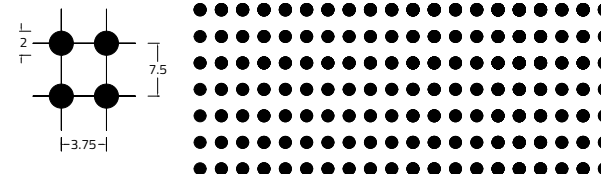

E - AP3

Ø 2.0 mm = 25% - diagonal pitch 3.5 mm

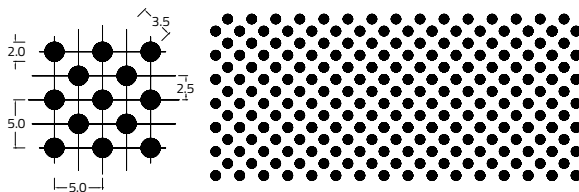

F - AP4

Ø 2.0 mm = 12.5% - parallel pitch 5 mm

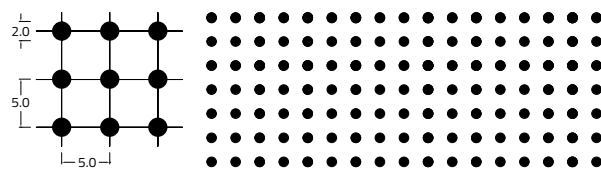

G - APQ2

2 x 2 = 4.5% - parallel pitch 9.5 mm

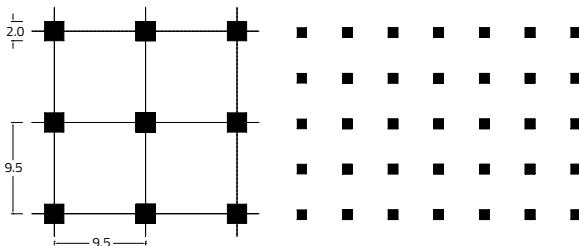

PERIMETRAL MOLDING

standard lenght 3000 mm

For special dimension perimetral moldings are available

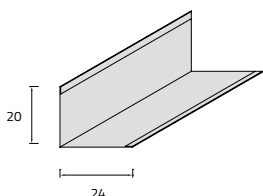

24 X 20
CP 10 aluminum 0.5/0.6 mm
A 3000/B - A 3000/B.1 - A 3000/N - A 3000/M
 steel 0.4/0.5 mm

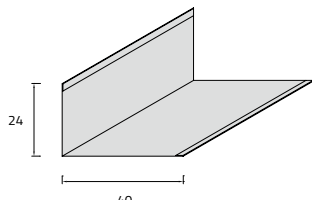

40 X 24
CP 50 aluminum 0.5/0.6 mm
A 3002/B - A 3002/N - A 3002/M
 steel 0.5 mm

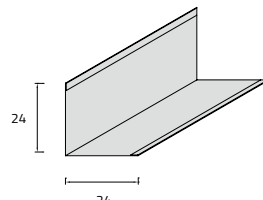

24 X 24
CP 10/1 aluminum 0.5/0.6 mm
A 3001/B - A 3001/B.1 - A 3001/N - A 3001/M
 steel 0.4/0.5 mm

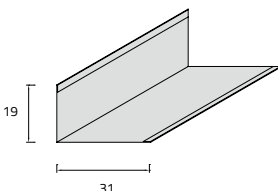

31 X 19
CP60 aluminum 0.5/0.6 mm
A 3003/B - A 3003/N - A 3003/M
 steel 0.5 mm

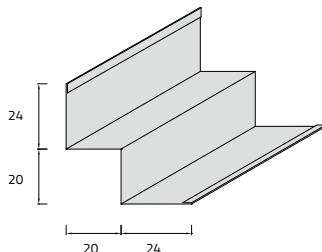

24 X 20 X 20 X 24
W 3003/B - W 3003/N - W 3003/M
 steel 0.5 mm

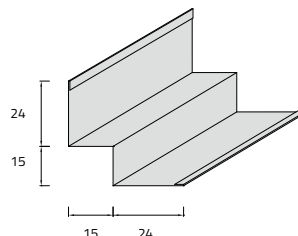

24 X 15 X 15 X 24
W 3004/B - W 3004/N - W 3004/M
 steel 0.5/0.6 mm

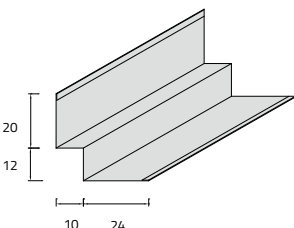

20 X 12 X 10 X 24
CF 10 aluminum 0.5 mm
W 3000/B - W 3000/N - W 3000/M
 steel 0.5 mm

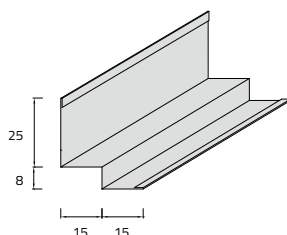

25 X 8 X 15 X 15
W 3002/B - W 3002/N - W 3002/M
 steel 0.5 mm

COLOURS RANGE

PREPAINTED STEEL

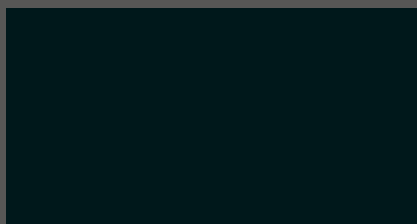

RAL 9005 - black

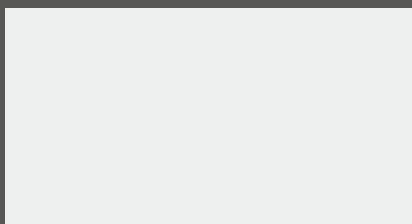

RAL 9003 - white

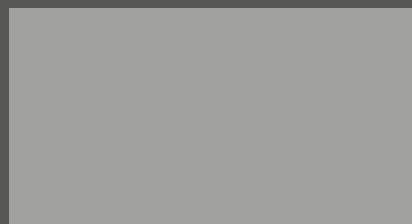

RAL 9006 - silver

PREPAINTED ALUMINIUM

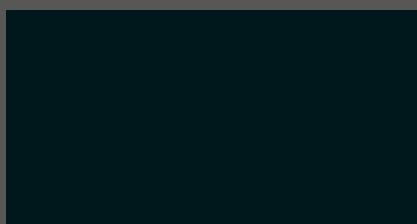

RAL 9005 - black

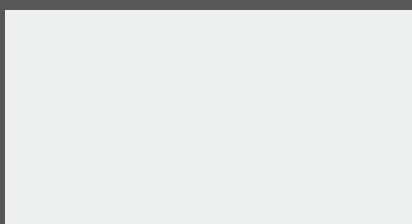

RAL 9003 - white

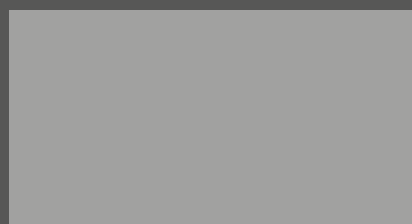

RAL 9006 - silver

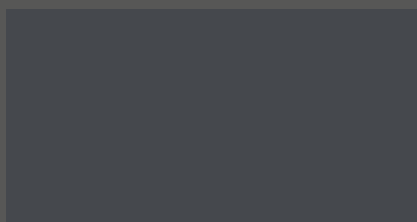

RAL 7024 - graphite grey

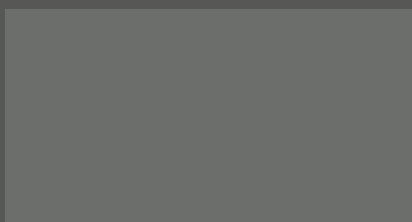

RAL 7005 - mouse grey

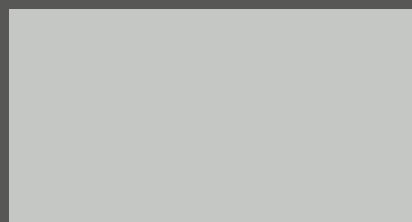

RAL 7035 - light grey

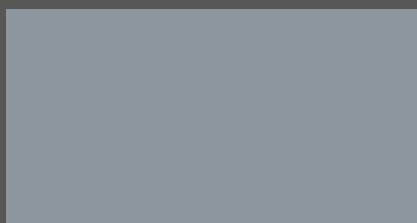

RAL 7001 - silver grey

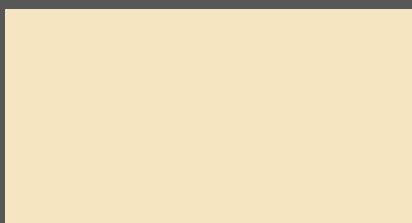

RAL 1015 - light ivory



RAL 1001 - beige

POSTPAINTED STEEL

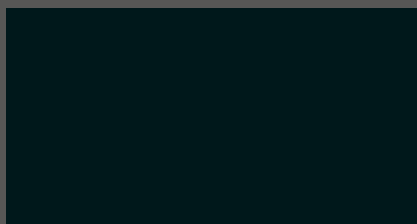

RAL 9005 - black

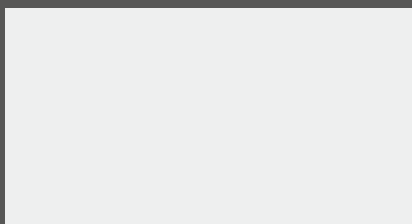

RAL 9003 - white



ALL RAL COLOURS

La cartella colori riportata in questa pagina è puramente indicativa, si raccomanda la richiesta di campionatura. Per altri colori chiedere la disponibilità in magazzino.

Per qualsiasi dettaglio, fare riferimento alla mazzetta colori RAL e la mazzetta colori esclusivi CBI, o contattare l'ufficio tecnico CBI Europe

FINISHES / WOOD COLLECTION



SL57 · whitened oak

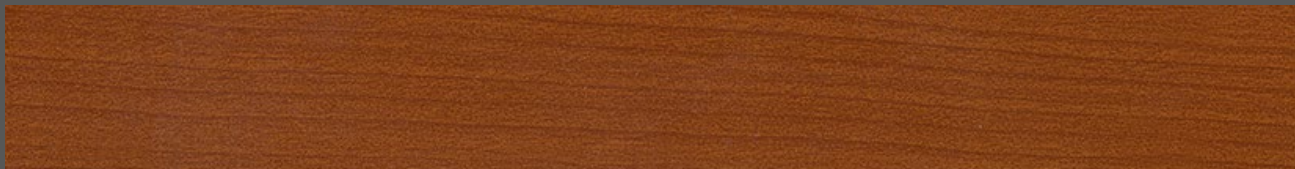

SL56 · cherry tree

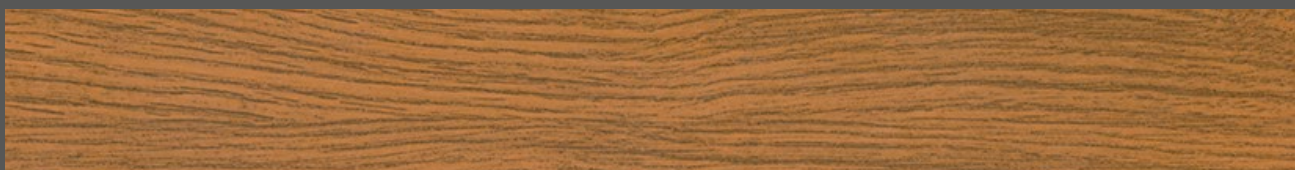

SL252 · winchester

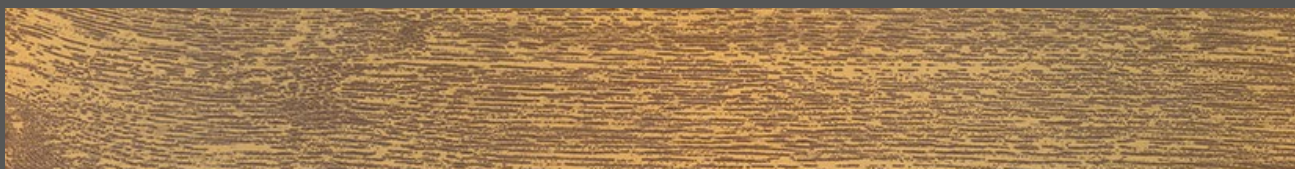

SL02 · light oak

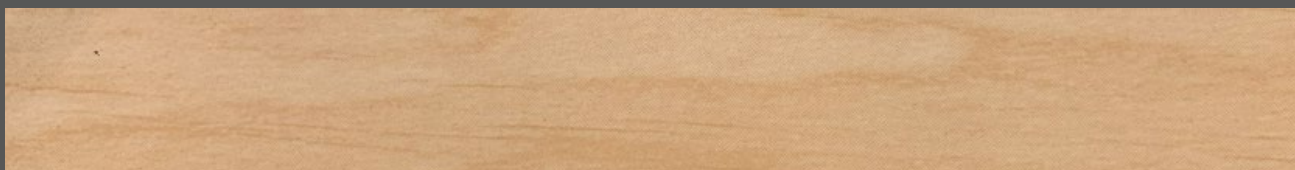

6869 · farm maple



SL28 · teak



SL39 · dark oak

The range of colors shown on this page is purely indicative and we are recommended that you request the samples for your color. Please ask about the availability of stock.

For further details refer to the bundle of RAL colors and CRI's exclusive color or bundles of PC or for the technical details to CBI Europe.